

Operation Instructions

RETRO-M

Retrofit Intercom & Music Distribution System



Thank you for purchasing an Intrasonic Technology product. Our products are built to provide you with years of high quality sound.

If you need assistance with the installation or operation of this product, please contact our Customer Service Support team at 1-877-435-0670. You may also get information on this and other Intrasonic Technology products on our website at www.intrasonictechnology.com

Table of Contents

<u>Topic</u>	<u>Page</u>
Cover	1
Table of Contents	2
Safety	3
FCC	3
Introduction	4
System Overview	5
Operational Controls	6
Master Settings	
❑ Clock	7
❑ Intercom Volume	7
❑ Radio Settings	7
❑ Auto On/Off	8
❑ Firmware	8
❑ Auxiliary Input Setup	8
❑ Reset	9
❑ Unit Setup	9
❑ Monitor	10
❑ Radio Presets	11
❑ Selecting the Input Source	12
❑ Room Station Operation	13
❑ Patio Station Operation	13
❑ Door Station Operation	14
❑ Door Station Volume	14
❑ Limited 2 year Warranty	15

Safety

Please read all instructions carefully before operating the RETRO-M music communication system.

- A Read these instructions.
- B Keep these instructions.
- C Heed all warnings.
- D Follow all instructions.
- E Do not use this apparatus near water.
- F Clean only with a dry cloth.
- G Do not block any ventilation openings, and install in accordance with the manufacturers instructions.
- H Only use attachments and accessories specified by the manufacturer.
- I Do not expose to moisture. This can cause shock hazards or create fire and void the warranty.
- J Do not service this product yourself. Attempting to service this product may expose you to high voltage and will void the warranty. Please contact a qualified local dealer for service.
- K Any substitutions of non-Intrasonic Technology products may result in electrical shock or other hazards.
- L The apparatus should not be exposed to dropping or splashing of liquids. No objects filled with liquids, such as vases, should be placed on the apparatus.

WARNING: To reduce the risk of fire or electric shock, do not expose this apparatus to rain or moisture.



ATTENTION - POUR RÉDUIRE LE RISQUE DE CHOC ÉLECTRIQUE, NE PAS RETIRER LE COUVERCLE (OU L'ARRIÈRE). NON UTILISATEUR À L'INTÉRIEUR. VOIR À UN PERSONNEL QUALIFIÉ.

CAUTION - TO REDUCE THE RISK OF ELECTRIC SHOCK, DO NOT REMOVE COVER (OR BACK). NO USER-SERVICEABLE PARTS INSIDE. REFER TO QUALIFIED SERVICE PERSONNEL.

FCC

This device complies with Part 15 of the FCC rules. Operation is subject to the following two conditions; (1) this device may not cause harmful interference, (2) this device must accept any interference received, including interference that may cause undesirable operation.

Warning: Changes or modifications to this unit not expressly approved by the party responsible for compliance could void the users authority to operate the equipment.

Note: This equipment has been tested and found to comply with the limits for a Class B digital device, pursuant to Part 15 of the FCC rules. These limits are designed to provide reasonable protection against harmful interference in a residential installation. This equipment generates, uses, and can radiate radio frequency energy and, if not installed and used in accordance with the instructions, may cause harmful interference to radio communications. However, there is no guarantee that interference will not occur in a particular installation. If this equipment does cause harmful interference to radio or television reception, which can be determined by turning the equipment on and off, the user is encouraged to try to correct the interference by one or more of the following measures;

- Reorient or relocate the receiving antenna.
- Increase the separation between the equipment and the receiver.
- Connect the equipment into an outlet on a circuit different from which the receiver is connected.
- Consult with the dealer or an experienced radio technician for help.

Introduction

The RETRO-M is a Music Distribution and Intercom system that integrates with today's portable music players, with a modern look that compliments any décor. It's a dual source system which allows you to select between two music sources with intercom capability. Listen to your home entertainment through the auxiliary input throughout your home. The RETRO-M not only allows you to use your portable hand held music players with the system, but also offers you the comfort and convenience of communication and room monitoring. With features like Automatic Selective Call and a full function remote control (at the master only), it is a convenient to use and offers exceptional value.

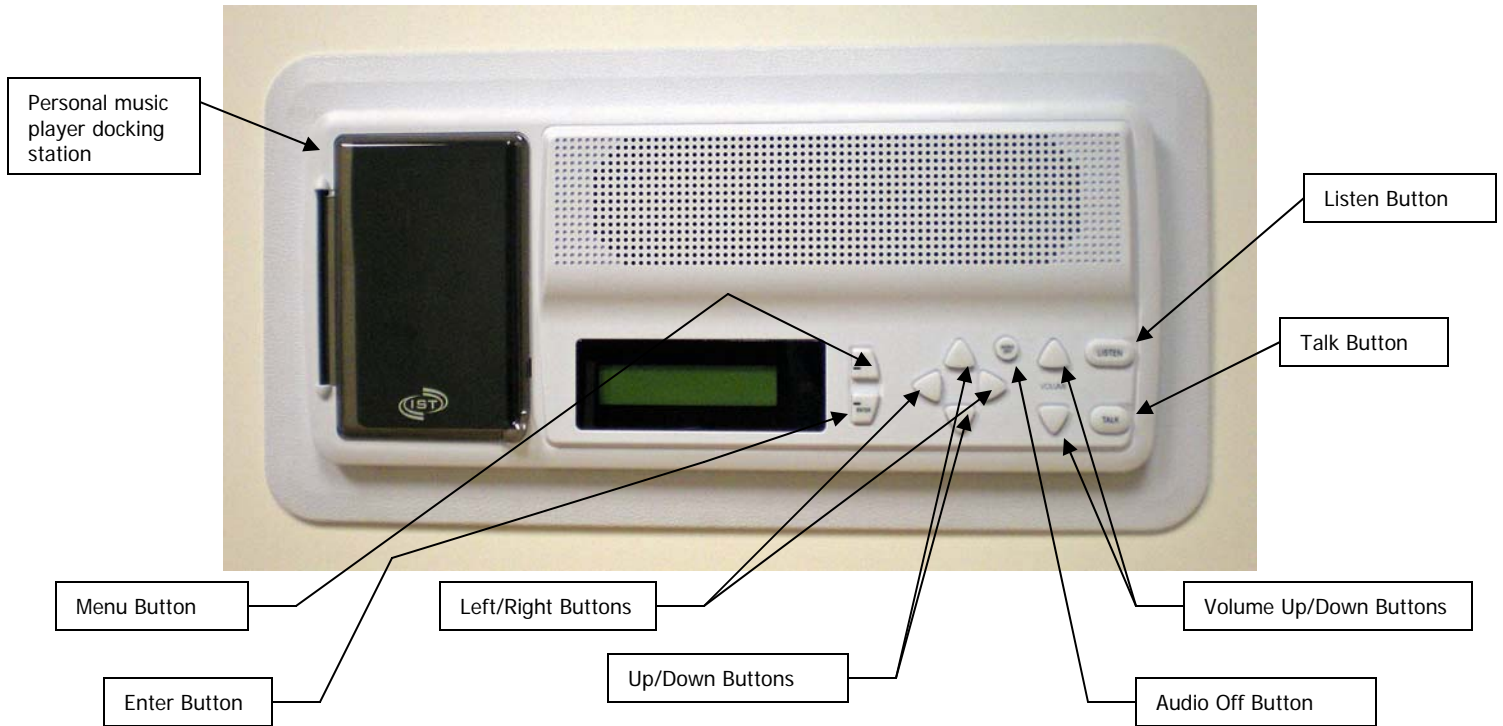

System Overview

RETRO-M Music Communications System is made up of 5 components.

- ❑ Master unit
- ❑ Room stations
- ❑ Patio stations
- ❑ Door stations
- ❑ Auxiliary input wall plate (maximum one per system)

Master Unit

The RETRO-M master unit allows control of the music and intercom functions. It enables you to set the system music and intercom volume levels, bass and treble levels, clock settings, privacy settings and more. The integrated docking station allows you to play any portable music source throughout the system.

Room Station

The RETRO-5R room station is designed for indoor use. It allows you to select between intercom, radio and portable music sources. You can also communicate with other stations including the master and the door stations.

Patio Station

The RETRO-5P patio station is weather resistant. It is designed for outdoor use in protected areas. The patio station can provide intercom communication and music. The door chime will sound at the patio station so guest will not be missed.

Door Station

The RETRO-D door station is designed for outdoor use in protected areas. It will allow communication with the master, room and patio stations and verify who is there before opening the door.

Operational Controls

Integrated Docking Station

Located on the master, the docking station allows you to plug in any portable music player into the system. The device can be charged through the USB or Firewire ports provided. Most hand held devices will fit inside the docking station along with their cables. Larger devices such as portable CD players can be plugged into the docking station and played through the system, but will not fit inside the docking compartment.

Note: Due to the variety of portable music devices and the number of different charging modes, we can not guarantee that all portable devices will charge with the provided Firewire and USB ports.

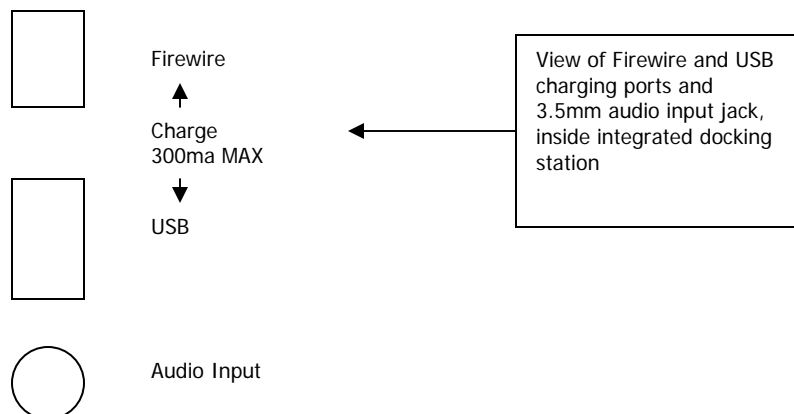

MENU/ENTER Buttons

The EXIT/ENTER buttons located on the front of the master are multi-functional switches used in conjunction with the LCD display. These buttons allow programming of various functions and features of the system.

Volume

The volume control on the master controls the volume of the master. The volume control on the room and patio stations will control their individual volume settings.

Audio On/Off Button

This shuts off the AM/FM radio and the MP3 music at the master and all room stations. This does not shut off intercom functions. If pressed and held for more than 3 seconds, it will monitor the door station.

UP/DOWN and LEFT/RIGHT Buttons

These buttons are designed for multi-functions, such as the following;

- UP/DOWN Buttons
 - ❑ Scrolling the menu content
 - ❑ Changing the AM/FM tuner presets
 - ❑ Changing characters
- LEFT/RIGHT Buttons
 - ❑ Moving the display cursor
 - ❑ Changing the radio frequency

Privacy

The privacy feature will prevent the station from being monitored. This feature is to ensure privacy at the location.

Listen Button

The listen button is used for hands free operation for the receiving side of the call. By pressing and holding the listen button, the responding party can reply without the need to press any buttons. In most cases the responding party does not need to be next to the station to reply. The built in microphone will pick up voice communication in most size rooms.

Talk Button

The talk button is used to communicate with the room, patio and door stations. After the talk button is pressed (this is an all broadcast) and once the responding station has pressed their talk button within 25 seconds, the selective call feature is activated. This means all stations not on this call will return to the music they were listening to before the first call.

Unlock the Door

The unlock the door feature allows you to unlock any door from the master or room stations. This optional feature is only available when installed.

Set Button

This is a multi-function key. It is used to save settings and return to the previous menu. It can also unlock the door if this option is available.

Getting Started

When you first turn the power on, the following screen will appear.

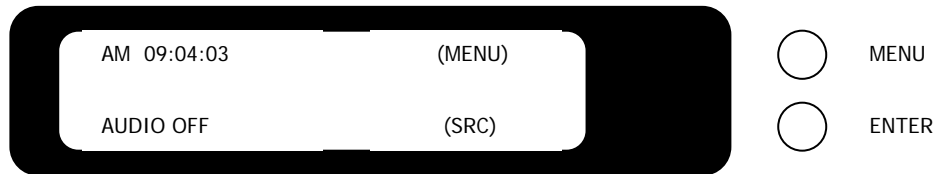

In the upper left corner of the screen the time is displayed. First will be either AM or PM, then the time will be displayed on hours, minutes and seconds.

The word MENU will be in the upper right corner. Pressing the Menu button will take you to other setup screens.

In the lower left corner it will say AUDIO OFF. This is a system default when power is lost. Simply press the Audio Off button on the front of the master to restore audio programming.

In the lower right corner the (SRC) stands for Source. By pressing the ENTER button, you can select between AM radio, FM radio and the auxiliary sources.

Master Settings

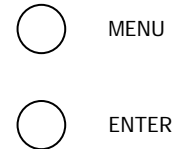
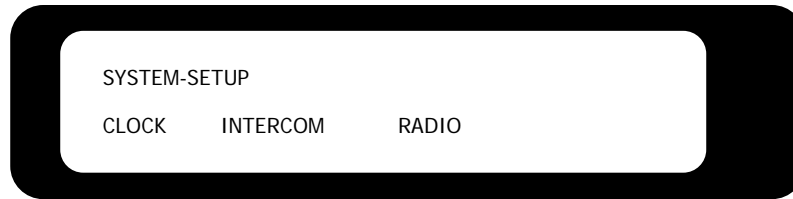

Clock

From the main screen press **MENU**. Using the **LEFT/RIGHT** buttons, select SYSTEM by pressing the **ENTER** button

Press the **ENTER** button while the cursor is on the word clock

12H PM (time) should appear on the second line

Press the **UP/DOWN** buttons to select 12 or 24 hour clock

Press the **RIGHT** button and then the **UP/DOWN** buttons to select AM or PM

Press the **RIGHT** button to select the hours and the **UP/DOWN** buttons to set the hour

Press the **RIGHT** button to select the minutes and the **UP/DOWN** buttons to set the minutes

Press the **ENTER** button to save clock settings

Press the **MENU** button 3 times to return to the main screen

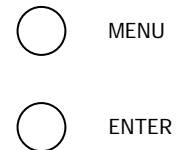
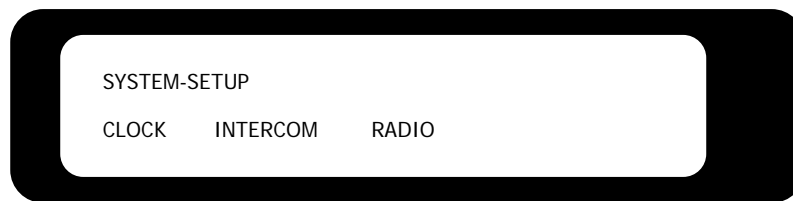

Intercom Volume

From the main screen press **MENU**. Using the **LEFT/RIGHT** buttons, select SYSTEM by pressing the **ENTER** button

Use the **RIGHT** button to move the cursor to the word INTERCOM

Press the **ENTER** button while the cursor is on the word INTERCOM

Intercom volume-set should appear on the display

Press the **UP/DOWN** buttons to set the intercom volume level

Press the **ENTER** button to save intercom volume setting

Press the **MENU** button 2 times to return to the main screen

Radio, AUX1 & AUX2 Bass, Treble and Volume Settings

From the main screen press **MENU**.

Use the **LEFT/RIGHT** buttons to move the cursor to the word radio

Press the **ENTER** button to enter radio setting options

Bass, treble volume should appear on the display

While the cursor is on the word bass, press the **ENTER** button

Using the **UP/DOWN** buttons, set the bass to the desired level and press **ENTER** to enter this setting

Press the **RIGHT** button to move the cursor to treble and press the **ENTER** button

Using the **UP/DOWN** buttons, set the treble to the desired level and press **ENTER** to enter this setting

Press the **RIGHT** button to move the cursor to volume and press the **ENTER** button

Using the **UP/DOWN** buttons, set the radio volume to the desired level and press **ENTER** to save this setting

Press **MENU** to exit this setup screen

Auxiliary bass, treble and volume adjustments can be accomplished by using the **LEFT/RIGHT** buttons to select AUX, pressing **ENTER**, then select VOLUME, BASS, or TREBLE with the **LEFT/Right** buttons, press **ENTER** and adjust using the **UP/DOWN** buttons. Once finished press **ENTER** for each selection and then press **MENU** 3 times to return to the main screen

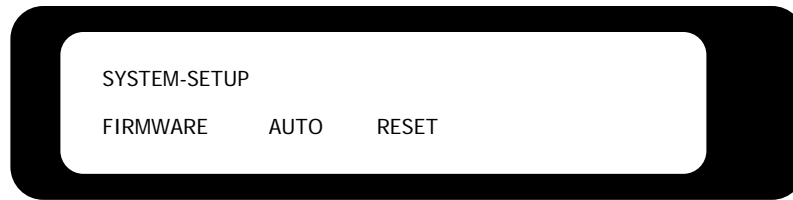

- MENU
- ENTER

Auto On / Auto Off

From the main screen press **MENU**. Using the **LEFT/RIGHT** buttons go to SYSTEM and press **ENTER**. Using the **LEFT/RIGHT** buttons scroll to the right until the screen above appears and select **AUTO**. Press **ENTER** to setup mode, Auto-On Auto-Off should appear on the display. With the cursor on Auto-On press **ENTER**, Enable PM 12:00 should appear on the display. Use the **UP/DOWN** buttons to scroll between Enable & Disable, if you selected Disable press **MENU** button to exit. If you selected Enable, use the **RIGHT** button to select PM then use the **UP/DOWN** buttons to select AM or PM. Use the **RIGHT** button to select the time and use the **UP/DOWN** buttons to set the hour and minutes you would like the system to come on. Press **ENTER** to your settings. If you Enabled the Auto-On feature, you may want to have the system shut off automatically. To do this use the **RIGHT** button to select Auto-Off and press **ENTER** to the setup mode. Then follow the same procedure for setting up the Auto-Off feature as you did for the Auto-On feature above. Once set, press **ENTER** to save your settings and the **MENU** button 3 times to return to the main screen.

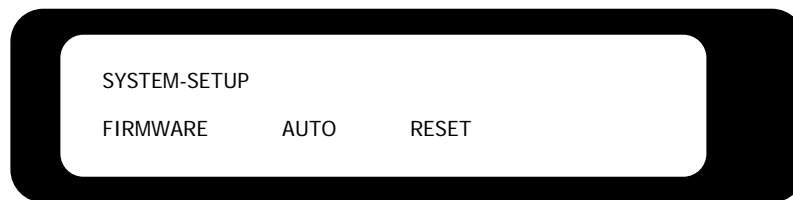

- MENU
- ENTER

Firmware

For trouble shooting purposes, it may be necessary to look up the revision of the system firmware. From the main screen press **MENU** and using the **LEFT/RIGHT** buttons select SYSTEM and press **ENTER**. Using the **LEFT/RIGHT** buttons to select Firmware on the display and press the **ENTER** button. The revision level of the Firmware will display on the screen. To exit simply press **ENTER**. Pressing the **MENU** button 2 times will return the system to the main screen.

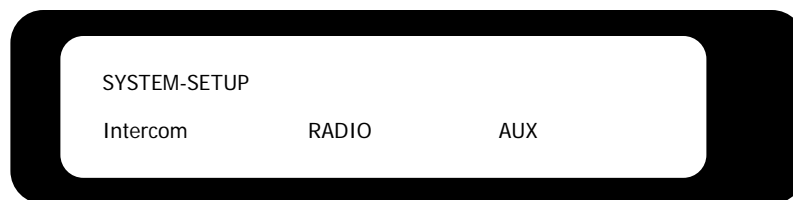

- MENU
- ENTER

Auxiliary Input Setup

From the main screen press **MENU**. Using the **LEFT/RIGHT** buttons select SYSTEM and press **ENTER**. Using the **LEFT/RIGHT** buttons select AUX and press the **ENTER** button. VOLUME, BASS and TREBLE will appear on the display, using the **LEFT/RIGHT** buttons select BASS and press **ENTER**. The bass level will appear as 00, using the **UP/DOWN** buttons set the bass to the desired level, press **ENTER**. Using the **LEFT/RIGHT** buttons scroll to treble and press **ENTER**, the treble level will appear as 00, using the **UP/DOWN** buttons set the treble to the desired level and press **ENTER**. Using the **LEFT/RIGHT** buttons select volume and press **ENTER**, using the **UP/DOWN** buttons set the volume to the desired level and press **ENTER**. Press the **MENU** button 3 times to return to the main screen.

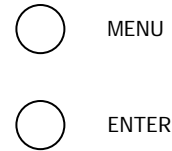
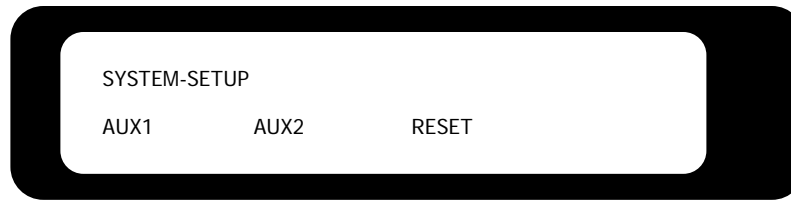

System Reset

From the main screen press **MENU**. Using the **LEFT/RIGHT** buttons move cursor to SYSTEM and press **ENTER**
 Using the **LEFT/RIGHT** buttons move the cursor to RESET
 With the cursor on Reset, press **ENTER**, Reset & Reset (ALL) will appear on the display
 With the cursor on reset press **ENTER**, and then press **MENU** (YES) to confirm reset or **ENTER** (NO) to cancel reset
 Using the **LEFT/RIGHT** buttons set the cursor on Reset (ALL) and press **ENTER**
 Press **MENU** (YES) to confirm reset or **ENTER** (NO) to cancel reset
 Press **MENU** button 3 times to return to the main screen

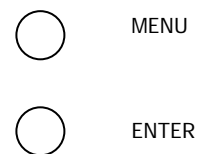
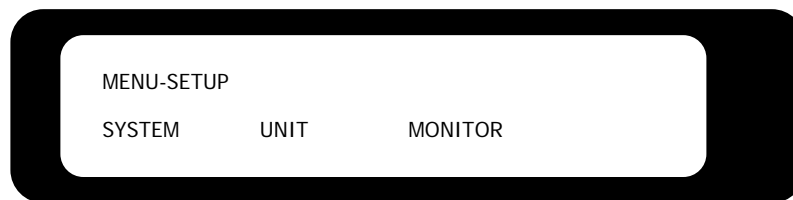

Privacy

From the main screen press **MENU** Then using the **LEFT/RIGHT** buttons select UNIT.
 Using the **UP/DOWN** buttons select which station you want to place in privacy mode and press **ENTER**
 With the cursor on Privacy press **ENTER** and use the **LEFT/RIGHT** buttons to select either OFF or ON for the privacy function at the master and press **ENTER** to select your choice

Display Backlight

From the main screen press **MENU** then using the **LEFT/RIGHT** buttons, select UNIT and press **ENTER**
 Under UNIT-SETUP with Master displayed, press **ENTER**
 Use the **LEFT/RIGHT** buttons to select LIGHT and press **ENTER**
 Use the **LEFT/RIGHT** buttons to select either OFF, LOW or HIGH for the brightness of the display, press **ENTER** to select your choice
 Press **MENU** 3 times to return to the main screen

Room/Patio Setup

From the main screen press **MENU** then using the **LEFT/RIGHT** buttons select UNIT and press **ENTER**
 Use the **UP/DOWN** buttons to select a room station for setup, press **ENTER** to setup screen, for the first room station R01-Setup & Mode Name should appear on the display
 With the cursor on Mode press **ENTER**, you can now use the **LEFT/RIGHT** buttons to select Normal, Audio, Intercom or Off, Normal is all functions work at the station, Audio is music only at the station, Intercom is intercom only at the station and off turns off all functions at the station
 Once you have selected the mode of operation press **ENTER** to keep your selection

Name/Number Room & Patio Stations

Using the **LEFT/RIGHT** buttons move the cursor to Name and press **ENTER**, you can now use the **LEFT/RIGHT** buttons to select the digit you wish to change and the **UP/DOWN** buttons to change that digit, you can scroll with the **UP/DOWN** buttons and select capital letters, a select set of cymbals or numbers for each digit
 Once you have selected the new name or number for the station, press **ENTER** to your selection
 Press **MENU** to return to the main screen, use the **UP/DOWN** buttons to scroll through the room stations, patio stations and door stations stopping on any station that you wish to change either the mode or name, follow the above steps to set the mode or name of any or all the room, patio or door stations

Monitor

Using the **LEFT/RIGHT** buttons place the cursor on Monitor and press **ENTER**

On/Off Select & Type should appear on the display

With the cursor on On/Off, press **ENTER** and then using the **LEFT/RIGHT** buttons select if you want the monitor function on or off and press **ENTER** to your selection

Using the **LEFT/RIGHT** buttons move the cursor to Select and press **ENTER**, you can then use the **UP/DOWN** buttons to select each station one at a time and the **LEFT/RIGHT** buttons to select if you want a specific station to be monitored or not, select Y for yes and N for no

Once you have selected those rooms you wish to have monitored, press **ENTER**

Using the **LEFT/RIGHT** buttons move the cursor to Type and press **ENTER**

Normal & Override show arrear on the display, normal is for room monitor only (no talk function) and override allows the monitored room to answer any intercom calls that might come in

Use the **LEFT/RIGHT** buttons to select either Normal or Override and press the **ENTER** button to your selection

Press the **EXIT** button to exit the monitor setup screen and press **EXIT** again to exit the Menu-Setup screen

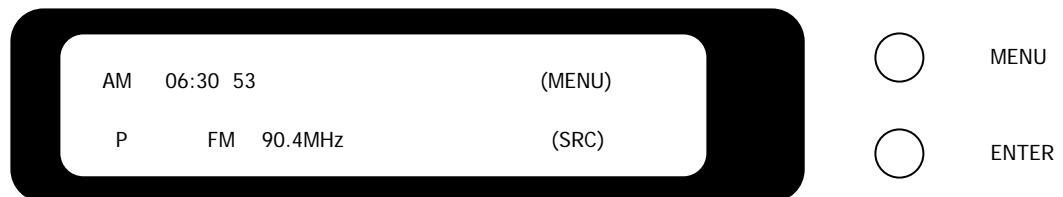

Radio Presets

To setup the radio presets, first go to the radio screen seen above by pressing the **MENU** button

There are 10 presets that can be set to either AM or FM stations

Press **ENTER** and FM AM AUX1 AUX2 will be displayed, using the **LEFT/RIGHT** buttons, select either AM or FM and press the **ENTER** button

Using the **LEFT/RIGHT** buttons select the frequency (station) you want to save and press **ENTER** (SAVE)

The screen should display PRESET NO XX, using the **UP/DOWN** buttons, select the preset number you want this station set to and press **ENTER**, this saves the selected frequency to the station preset you selected.

Repeat the above steps for the 10 preset positions, selecting AM or FM and the station frequency for each preset

HINT:

LEFT/RIGHT buttons can be either pushed momentarily or pressed and held for 3 seconds to engage automatic seek feature



Selecting the Input Source

From the main screen the **ENTER** button to get to the Source-Select screen

Press the **LEFT/RIGHT** buttons to select the source (FM, AM or AUX)

Press the **ENTER** button to activate the source selected

Set the volume by pressing the **VOLUME UP/DOWN** buttons

Note: The * located next to either the FM, AM or AUX indicates that this is the current source selected

Note: There are two auxiliary inputs available. The first auxiliary input is the 3.5mm jack inside the PMP (personal music player) docking station on the front of the master. The second and optional auxiliary input is an aux plate mounted to the wall and plugged into the AUX jacks located on the rear of the master station. The system works on a priority basis. That is the input located in the master docking station has priority over the wall plate aux input. If an input source is plugged into both of these, the one in the docking station will have priority and play. The only way to play the second aux input from the wall plate is to remove the source plugged into the docking station.

Room Station

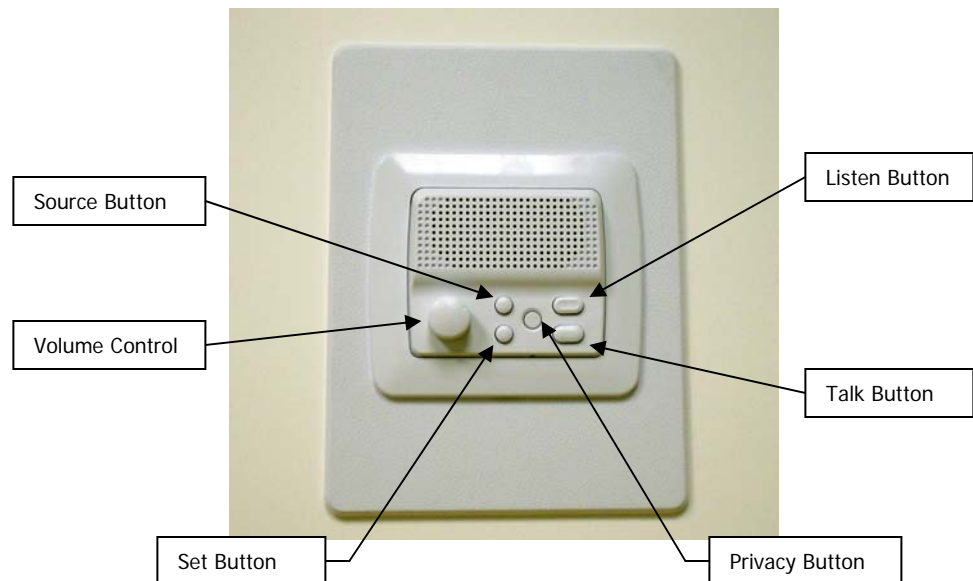

The **SOURCE** button is used to select the music source. One selection is the AM/FM radio. The second and third choices are Aux 1 and Aux 2. This input depends on which Auxiliary input is selected at the master. If the Personal Music player docking station is selected at the master, then this source will play through the room station. If the optional auxiliary wall input is selected, then this source will play at the room station.

The **LISTEN** and **TALK** buttons are for intercom operation. Pressing the **TALK** button is an “all call” to all other stations. Once a station responds, the call becomes private between the initial call station and the responding station. All other stations will automatically return to the music they were listening to before the initial call was made. This feature is called Automatic Selective Call.

Pressing the **PRIVACY** button will stop another other station from listening to or monitoring the room station. To cancel the privacy function, simply press the **PRIVACY** button again.

Pressing the **SET** button will activate the optional door unlock feature.

The **VOLUME** knob controls the volume of the music and intercom functions. With this feature the user can set the desired volume for each room individually.

To listen to the door station, press and hold the **Source** button for 5 seconds. To turn off the door listen function, simply press the **Source** button again or let the system time out and the door listen function will cancel after 30 seconds.

Patio Station

The patio station looks and operates just the same as the room station with one exception. For security reasons there is no **LISTEN** button on the patio station.

Answering the Door

Once someone has pressed the door bell button on the door unit, the system will mute the music at the master and rooms stations and the chime will be heard. To answer the door station simply press the TALK button on the master or any room station. To listen to the door unit again, release the TALK button. Once you answer the door unit from the master or any room station, all other stations will go back to the music they were listen to before the door unit was activated. The communication from the door unit will remain active as long as there is communication between it and another inside station. Once there is no communication for a period of 30 seconds, the door communication will be de-activated and the inside station that was communicating with the door, will return to its music source.

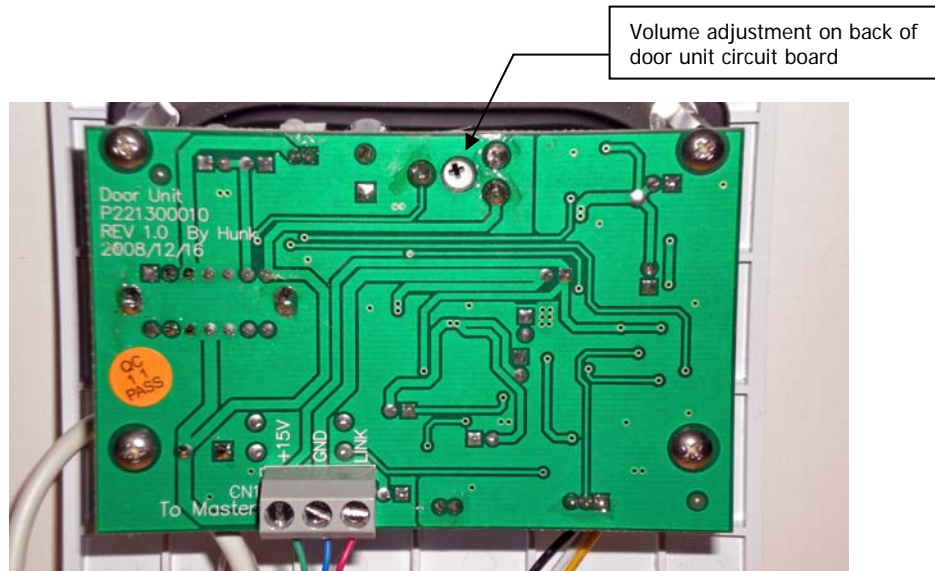

Door Station Volume

The volume of the door station can be adjusted from the back of the door unit. This adjusts only the speaker volume of the door unit itself. See the exhibit above to identify the volume control adjustment screw.

Selecting the Door Chime

There are 5 different chimes available.

From the main screen press **MENU** then using the **LEFT/RIGHT** buttons, select UNIT and press **ENTER**

Using the **UP/DOWN** buttons select the door station you want to set the chime for and press **ENTER**

Using the **LEFT/RIGHT** buttons select CHIME and press **ENTER**

The numbers 1-5 will appear on the display, using the **LEFT/RIGHT** buttons select from the 5 available chimes

Press **ENTER** to set the selected chime for this door station

Press the **MENU** button 3 times to return to the main screen



Intrasonic Technology 2 Year Limited Warranty

Intrasonic Technology warrants its products to be free of manufacturing defects for two years from the date of closing or actual installation. This warranty only applies to products purchased from authorized dealers and distributors. If proof of installation cannot be supplied, the manufacturing date code may be substituted. This warranty extends to the original user or subsequent owner of the product during the warranty term. Intrasonic Technology will replace or repair the product at its option at no charge with a rebuilt or new product. All products with manufacturing defects must be returned to Intrasonic Technology.

If an Intrasonic Technology product is determined to have a defect, please call our toll free number (877-435-0670) before any attempt to dismantle or repair the product. Any attempt to dismantle or repair the product will void the warranty.

An RMA (Return Material Authorization) will be required prior to returning a product to Intrasonic Technology. To obtain an RMA number, call our toll free number (877-435-0670) and speak with a customer service representative. All products returned without an RMA number will be refused.

The limited warranty is in lieu of any other warranty, expressed or implied and any other obligations or liability on the seller's part. The limited warranty does not cover service calls, damage caused by improper installation, acts of God, or violation of building or electrical codes.

Intrasonic Technology will not be liable for consequential, incidental or other damage arising in connection with use or inability to use this product. In no event shall Intrasonic Technology's liability hereunder exceed the cost of the product covered hereby. No person is authorized to assume for Intrasonic Technology or obligate Intrasonic Technology for any other liability in connection with the sale of this product. Some states do not allow exclusion or limitation of consequential, incidental damage, so the above limitation or exclusion may not apply. This limited warranty gives you specific legal rights, and you may also have other rights, which may vary from state to state.