



dmc1 Finish-Out Instructions

Introduction

Designed for installation in new home, the dmc1 is a whole-house music communications system. It is designed to provide years of enjoyment and service to the homeowner.

M&S audio products are backed with more than 50 years of experience in the design and manufacture of precision acoustical equipment for the home. To ensure that the homeowners receives the high-quality music and voice reproduction that the system is designed to deliver, it is important that each step of the installation be done carefully. In the event you need troubleshooting assistance, please call our technical staff at 1-800-366-9422.

Prior to installing the dmc1 system, read and observe the Important Safety Instructions on page 2.

Our web address is www.mssystem.com.

Important Safety Instructions

**READ ALL INSTRUCTIONS CAREFULLY BEFORE
INSTALLING OR USING THE DMC1 SYSTEM**

**FOR CONTINUED PROTECTION AGAINST RISK OF FIRE
REPLACE THE FUSE IN THE POWER SWITCH MODULE ONLY
WITH SAME TYPE 6 AMP, 120 VOLT FUSE.**

**THE dmc1 MUST BE INSTALLED BY A M&S SYSTEMS DEALER OR
INSTALLERS, AND MUST CONFORM TO ALL LOCAL BUILDING
AND ELECTRICAL CODES.**

Warning: always follow these safety instructions.

Retain these instructions for future system reference.

- Adhere to all warnings on the dmc1 and in these instructions. Follow all operating and installation instructions.
- **CAUTION:** These installation and servicing instructions are for use by qualified personnel only. To reduce the risk of electric shock, do not perform any servicing other than that contained in the operating instructions unless you are qualified to do so.
- **DO NOT** attempt to service the dmc1 yourself as opening or removing covers may expose you to dangerous voltage or other hazards. Refer all servicing to qualified service personnel.

The lightning flash with arrowhead symbol within an equilateral triangle is intended to alert the user to the presence of uninsulated “dangerous voltage” within the product’s enclosure that may be of sufficient magnitude to constitute a risk of shock to persons.

The exclamation point within an equilateral triangle is intended to alert the user to the presence of important operating and maintenance (servicing) instructions in the literature accompanying the product.

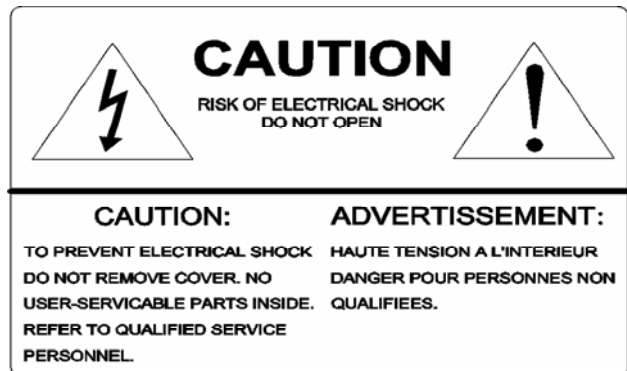

- Finish out the dmc1 system after the application of wall covering material.
- **Do not** power up the dmc1 master until all remote stations and speakers are connected.
- **Do not** connect a CAT-5 wire if you are unsure of it terminating point. Connecting a door speaker to a room station may result in system damage.
- **Do** ensure that all rough-in instructions have been followed before power is applied to the dmc1 system.
- **Do not** splice cables. Splices are unreliable and defeat the signal isolation properties of the cable.
- **Do not** attach devices unauthorized for use with this system. Authorized devices include:
 - Audio components connected via a line level input
 - DMC1CD 6-disc player
- If extra cables have been run for future speaker additions, care must be taken to ensure these cables are not connected to the dmc1 master unit. Un-terminated cables (no station) connected to the dmc1 master may cause electronic feedback that will damage the master unit.

- **Do not** over-tighten the screws for the remote stations or the master as the plastic face panels may crack or strip out.
- Use only M&S Systems certified replacement parts and have them installed by an M&S Systems dealer or installer. Unauthorized substitutions can result in fire, electric shock, or other hazards.
- Upon completion of any service or product repair, have the M&S Systems dealer or installer conduct a safety check to ensure the system is in proper operating condition.
- Use only a damp cloth to clean the dmc1 master and room stations. Do not use liquid cleaners or aerosol cleaners.

Finish-Out Instructions

The finish-out installation should be made after the application of wall covering material.

Tools required:

- #2 Phillips screwdriver
- Standard flat head screwdriver
- Wire stripper/cutter
- Level

Installing the Room Station

Collect all the connectors included in the room station packages and place them in the wall housing for use later. At each room station location, strip approximately 4 inches of jacket from the CAT5 wire and separate the colored conductors from one another. Strip ½ inch of insulation from each conductor as shown in figure 1.

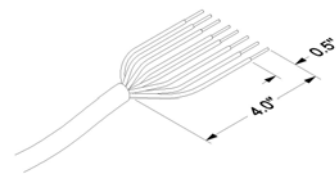

Figure 1 - CAT5 wire

Connect each colored conductor to its respective screw terminal. The screw terminals are marked with the appropriate wire colors. Note: Some screw terminals have more than one wire connected to them.

Mount each room station to its mounting ring using the two screws provided with each dmc1 room station as shown in figure 2.

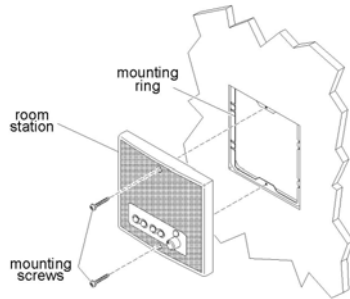

Figure 2 – Attaching the room station to the wall

Patio Station – DMC1RW

At each patio station location, strip approximately 4 inches of jacket from the CAT5 wire and separate the colored conductors. Strip 1/2 inch of insulation from each conductor and connect each colored conductor together using wiring wire nuts as shown in figure 3. Note: Some wires are doubled up when connected to the room station. Mount the patio station to the housing using the 2 screws provided with the room station.

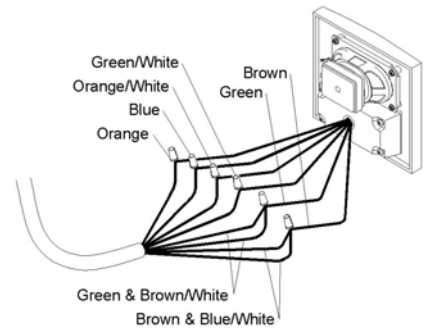

Figure 3 – Patio station wiring connections

Satellite Volume Control MVC1 Series

At each MVC1 location strip approximately 4 inches of jacket (MS4XSC and MS2SXSC) from wires and separate colored conductors from each other. Connect drain wires together from both cables using a wire nut (MS4XSC only). Wire nut each colored conductor to its respective wire as shown in figure 4. Connect blue and violet wires to the corresponding terminals of the satellite speakers. Mount the MVC1 to the single gang box using the two screws provided with the volume control.

The Green/White, Orange/White, Orange, and Blue wires are NOT connected at the DMC1 or MVC1 ends of the cable.

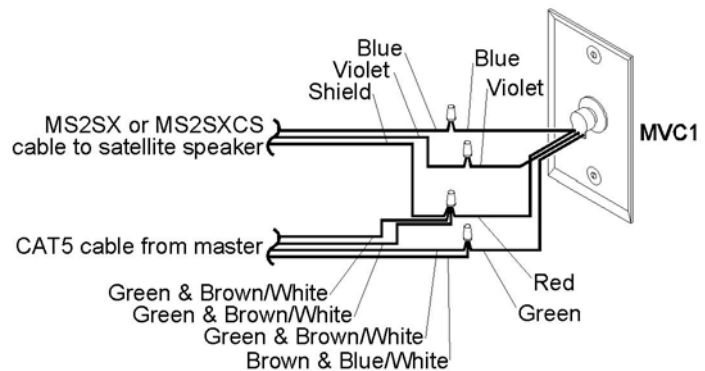

Figure 4 - Volume control wiring

External Music Source - AWP

Use the labels provided to mark respective cables. Connect the cables to the plate as shown in figure 5 and mount the plate using the two screws provided.

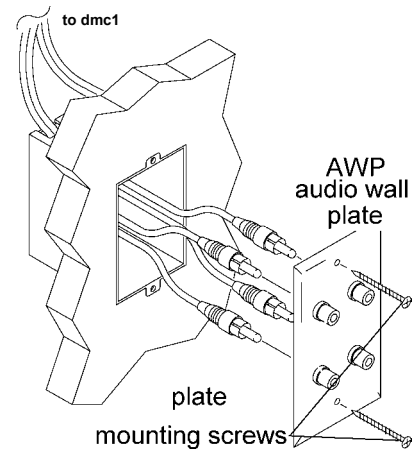

Figure 5 - External source wiring

Door Stations

At each door station location, strip approximately 4 inches of jacket from wire and separate colored conductors from one another. Strip ½ inch of insulation from conductors as shown in figure 1. Cut each shield drain wire at jacket to prevent them from touching each other (MS4DCXSC only). Terminate yellow and orange wires to the screw terminals on the bell button (if equipped). Connect the red and black wires to the red and black wires on the speaker respectively. Refer to figure 6. Mount door station to housing using the two screws provided with the door station.

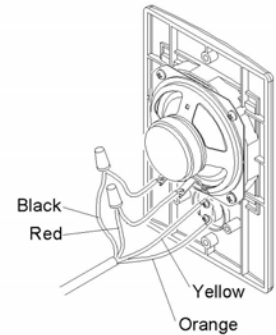

Figure 6 - Door station connections

dmc1 Master Installation

Gather all room station and door station cables and cut cable ends to the same length approximately 12 inches from entry point into wall housing. Make sure that all cables remain properly labeled. Strip approximately 2" of insulation from each of the CAT5 cables. Untwist the individual wire pairs. Insert each wire pair into the correct connector location and close connector (see figure 7). Insert each cable connector into its proper location on the dmc1 master. Note: Verify that the outdoor patio speaker is connected into the Patios station cables location only. If you are connecting two patio speakers, use the screw terminal connectors provided with the dmc1RW for the patio. Connect both patio stations cables into one screw terminal connector.

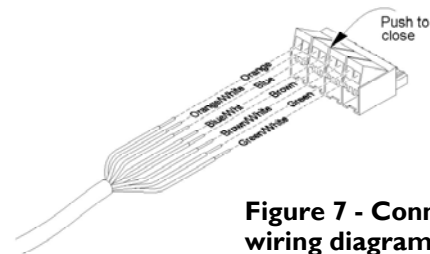

Figure 7 - Connector wiring diagram

Important: Verify all cable run locations prior to connecting if they were not labeled at rough-in. Incorrectly connecting cables to the master, room stations or door stations may result in system damage.

Install the optional chime module MC3 or MC8 in the wall housing by pressing the chime module over the 4 plastic standoffs attached to the wall housing as shown in figure 8. Refer to the instructions shipped with the chime module.

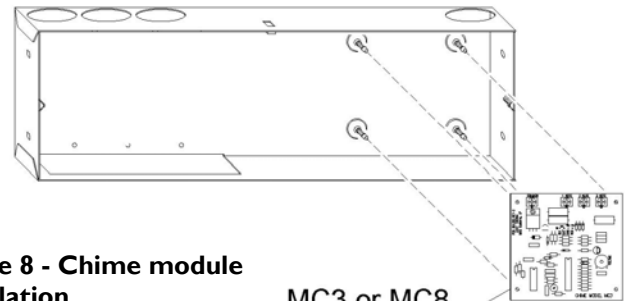

Figure 8 - Chime module installation

MC3 or MC8 Chime Module

Suspend the master unit from the wall housing by looping the third hand wire (thick green wire) over the hook at the top of the housing. Be careful not to damage the wall surface. See figure 9.

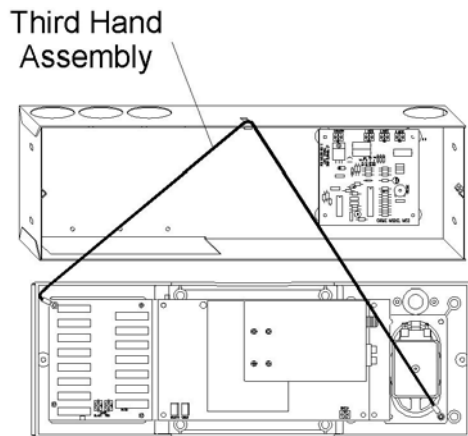

Figure 9 - Third hand assembly

If the dmc1 system has more than 9 room stations, some room selector switches will control two room stations. Do not exceed more than 15 total speakers on the system. This limitation does not include remote controls, volume controls, speakers connected to the optional stereo power amp, or door stations. The station location can be noted on the inside of the front access panel on the left side of the dmc1 master.

Connect the red and black wires of the door station cables

(MS4DCX/MS4DCXSC) to the red and black door speaker terminals on the dmc1 master as shown in figure 10. Insulate the bare wires using some of the jacket material to prevent shorting to the circuit board. Connect this wire to terminal labeled shield. Connect all orange wires from the door stations to the common terminal on the MC3 or MC8.

Connect each yellow wire to a note selection terminal. (Do not connect more than one yellow wire per note terminal.)

Plug in the modular chime plug to the 4 pin connector labeled as CHIME on the dmc1 master unit as shown in figure 10.

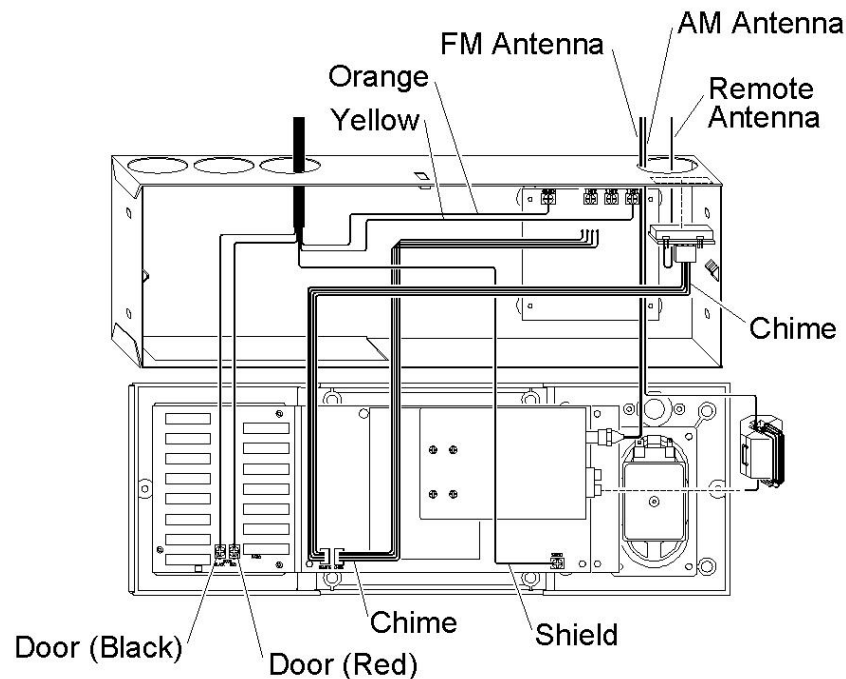

Figure 10 - dmc1 connections

Antenna Connection

Connect the FM dipole twin lead antenna to the FM 300 Ohm terminals on the dmc1 master as shown in figure 10. Connect the orange AM antenna wire to the AM terminal on the master.

Wireless Remote Control Connection

To install the optional wireless remote control receiver module MCRC, attach the MCRC module using the Velcro strips provided to the wall housing as shown in figure 10. Place the white antenna lead through the hole provided in the wall housing into the wall cavity. Failure to do so

may result in poor range of the wireless remote control system. Connect the wire harness from the MCRC to the connector labeled REMOTE on the master as shown in figure 10.

Door Release Connection

To use of the DRW door release, connect the VM127X cables from the remote power transformer and the DRW door release striker. The 24volt/4amp dry contact switch closure may also be used for home automation or security panel panic alarm interface. Note: The door release operation may only be used for one type of function per application.

Power Amp Finish-out

At each cable end, strip approximately 4 Inches of jacket (MS5XSC and MS2SXSC) from wires and separate colored wires from each other. Strip 1/2 Inch of insulation from each wire as shown in figure 1. On the MS7XSC, strip 1/4 Inch of insulation from each wire as shown in figure 2.

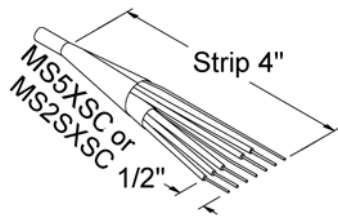

Figure 11 – MS5XSC/MS2SXSC Wiring

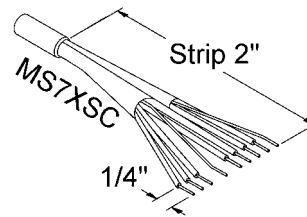

Figure 12 – MS7XSC Wiring

Satellite Volume Controls

Connect the shield wire from outside shield of the MS5XSC to the MS2SXSC shield wires. **DO NOT** connect the shield wire for the brown/gray pair at this end of the cable! Wire nut each colored wire to its respective wire as shown in figures 13-14 for the volume control to be used. Connect the BLUE and VIOLET wires to the corresponding terminals of the satellite speaker(s). Mount the volume control to the single gang box using the two screws provided with the volume control (refer to figure 15).

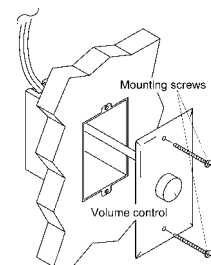

Figure 15 – Volume control mounting

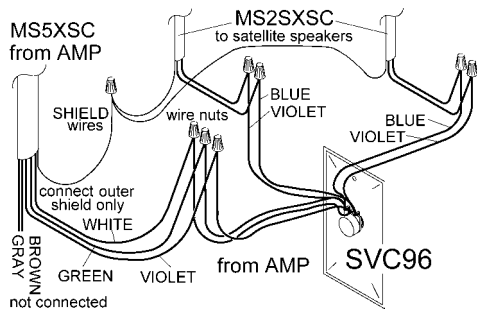

Figure 13 – Stereo wiring connections

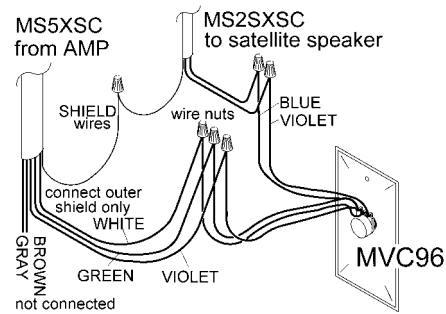

Figure 14 – Mono wiring connections

Satellite Speakers

At each speaker location, strip approximately 4 Inches of jacket from the MS2SXSC cables and separate the colored wires from each other. Strip 1/2 Inch of insulation from each wire. Connect the MS2SXSC cable to the speaker as shown in figure 8.

NOTE: The bare drain wire from the cable is not connected and should be cut off. On speakers equipped with RED and BLACK terminals, connect the BLUE wire to the BLACK terminal and the VIOLET wire to the RED terminal.

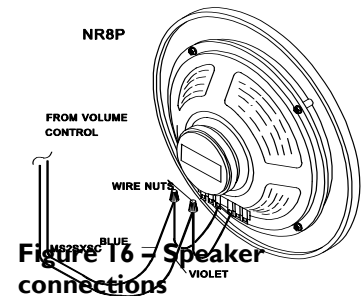

Figure 16 – Speaker connections

Amplifier Mounting

The amplifier module will install on a single vertical stud previously marked during rough-in. The vertical height of the amplifier will allow complete coverage over the wall openings for the remote volume controls and control panel wiring. Mark the location of the top mounting keyhole and bottom mounting holes. With the amplifier removed verify the location of the vertical stud by installing the enclosed mounting screws at the marked locations.

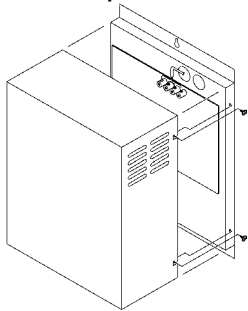

Figure 17 – Amplifier mounting

Once the location of the stud has been verified, remove the screws. Remove the cover from the amplifier. While positioning the amplifier (with cover removed) into position, bring the volume control and preamp cabling through the holes provided. Secure the amplifier to the wall in the

marked locations with the screws provided as shown in figure 17. **FAILURE TO PROPERLY MOUNT THE AMPLIFIER MAY LEAD TO AMPLIFIER DAMAGE AND/OR VOLUME CONTROL/PREAMP WIRING DAMAGE.**

dmc1 Connection

Locate the MS7X5SC cable from the dmc1 master. Connect each of the 7 colored wires and shield drain wire from the MS7X5SC cable to the 8 pin terminal block as shown in

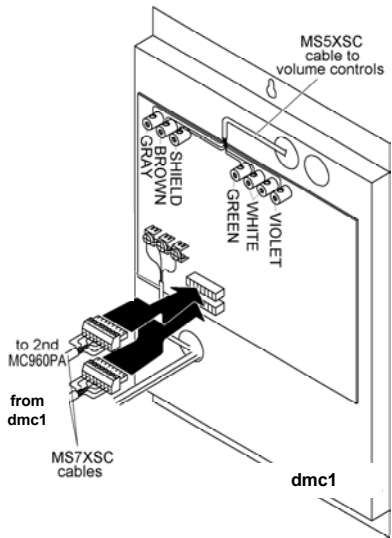

Figure 19 – Wiring connections

figure 18. Plug the 8 pin connector into the jack labeled PREAMP INTERCONNECT. Locate the MS7X5SC cable from the second power amplifier (MC960PA), if used. Connect each of the 7 colored wires and shield drain wire from the MS7X5SC cable to the 8 pin terminal block as shown in figure 18. Plug the 8 pin connector into the jack labeled TO SECOND AMP.

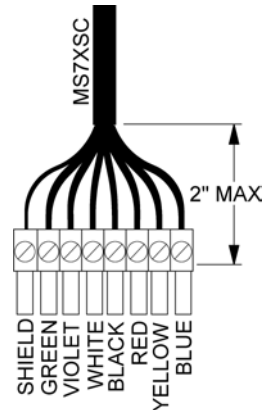

Figure 18 – Wiring diagram

Gather all volume control cables (MS5XSC). Pigtail all shield drain wires (bare) from the MS5XSC cables to the SHIELD terminal on the remote amplifier. Then connect each of the color-coded wires to its respective terminals as shown in Figure 19.

Stereo/Mono Configuration

Each MC960PA remote amplifier is equipped with a stereo/mono select jumper. All MC960PA amplifiers are shipped from the factory with this jumper in the STEREO position. If an amplifier is required to drive more than 10 monaural speakers, this jumper must be set to the MONO position (refer to figure 20).

Setting the jumper to the MONO position will cause monaural output to all speakers whether they are connected via stereo controls or mono controls. The jumper setting of one MC960PA amplifier has no effect on other MC960PA amplifiers.

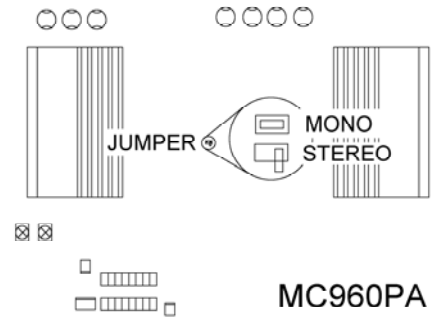
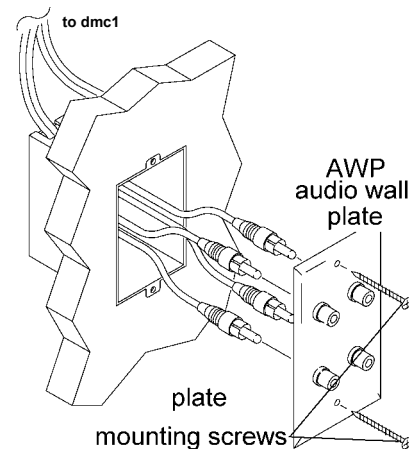

Figure 20 – Jumper connections

Other Sources

Plug in the RCA phono plugs to the jacks as marked for the source equipment. Figure 21 shows a typical installation using the AWP/AWPRX audio wall plate installation kit.

Figure 21 – AWP audio plate connections



Powering Up The dmc1

After all connections have been made, insert the power plug into the transformer and secure the master to the wall housing using the 2 screws provided. If using the dmc1F frame with a dmc1CD player, install the master unit over the frame. Do not over tighten the screws as the plastic may distort or crack. Install the speaker panel on the master as shown in figure 22.

Please be careful to only apply pressure on the speaker panel at the corners and not in the middle. Check all functions by following the guidelines in the Owners Manual shipped with the master unit. If any difficulties are encountered, recheck all connections. If after reviewing these instructions and you are unable to resolve any problems, contact technical support at 1-800-366-9422.

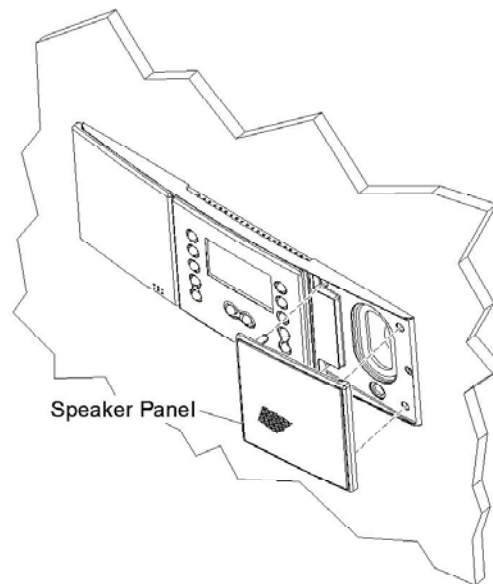

Figure 22 - DMC1 speaker cover installation

M&S Systems 2-Year Warranty

M&S Systems warrants its products to be free of defects for 2 years. Except for the AirVac Gold power units. The warranty period begins on either (a) the date of purchase or installation date of this product or (b) the date of closing on a new residence in which this product was originally installed. The warranty extends to the original user of the product and to each subsequent owner of the product during the term of the warranty. M&S will repair or replace, at its option, parts and materials at no charge. Parts supplied under this warranty may be new or rebuilt at the option of M&S Systems.

If during the warranty period the product appears to have a defect, please call our toll free service number (800-366-9422) prior to dismantling. Dismantling the product prior to calling our service number may void the warranty. Before returning any product to M&S Systems, obtain a Return Authorization Number (RAN) from our service department. M&S Systems will return the repaired product freight prepaid within the continental United States. ANY PRODUCT RETURNED TO M&S SYSTEMS WITHOUT A RAN NUMBER WILL BE REFUSED.

This limited warranty is in lieu of any other warranties, express or implied, including any implied warranty of merchantability or fitness for a particular purpose or otherwise, and of any other obligations or liability on the seller's part. This limited warranty does not cover damage caused by improper installation, acts of God, criminal acts, the violation of applicable building or electrical codes or the use of non-M&S wire, cable (excluding CAT5 and RG-6) or wall housings.

Under no circumstances shall M&S Systems be liable for consequential, incidental or special damages arising in connection with use, or inability to use this product. In no event shall M&S Systems liability hereunder exceed the cost of the product covered hereby. No person is authorized to assume for us or obligate us for any other liability in connection with the sale of this product. Some states do not allow the exclusion or limitation of consequential, incidental or special damages, so the above limitation or exclusion may not apply to you. This limited warranty gives you specific legal rights, and you may also have other rights, which vary from state to state.

116002