



## **dmc3-4 Installation Instructions**



## Introduction

Designed to update older intercom systems, the dmc3-4 is a whole-house music communications system that uses your existing intercom 3 or 4 conductor system wire. It is designed to provide years of enjoyment and service to the homeowner.

M&S audio products are backed with more than 50 years of experience in the design and manufacture of precision acoustical equipment for the home. To ensure that the homeowner receives the high-quality music and voice reproduction that the system is designed to deliver, it is important that each step of the installation be done carefully. In the event you need troubleshooting installation assistance, please call our technical staff at 1-800-366-9422.

Prior to installing the dmc3-4 system, read and observe the Important Safety Instructions beginning on page 3.

Our web address is [www.mssystem.com](http://www.mssystem.com). The M&S Systems web site contains additional information that will be of assistance in the installation and support of the dmc3-4 system and all other M&S Systems products. Including installation guides, configuration recommendations, brochures, product specifications and a frequently asked questions section.

# Important Safety Instructions

**READ ALL INSTRUCTIONS CAREFULLY BEFORE  
INSTALLING OR USING THE DMC3-4 SYSTEM**

**THE dmc3-4 MUST BE INSTALLED BY A M&S SYSTEMS DEALER  
OR INSTALLER, AND MUST CONFORM TO ALL LOCAL BUILDING  
AND ELECTRICAL CODES.**

**Warning: Always follow these safety instructions.**

**Retain these instructions for future system reference.**

- Read **ALL** safety and operating instructions before installing the dmc3-4.
- Adhere to all warnings on the dmc3-4 and in these instructions. Follow all operating and installation instructions.
- **CAUTION:** These installation instructions are for use by qualified personnel only. To reduce the risk of electric shock, do not perform any servicing other than that contained in the operating instructions unless you are qualified to do so.
- **DO NOT** attempt to service the dmc3-4 yourself as opening or removing covers may expose you to dangerous voltage or other hazards. Refer all servicing to qualified service personnel.

The lightning flash with arrowhead symbol within an equilateral triangle is intended to alert the user to the presence of uninsulated “dangerous voltage” within the product’s enclosure that may be of sufficient magnitude to constitute a risk of shock to persons.

The exclamation point within an equilateral triangle is intended to alert the user to the presence of important operating and maintenance (servicing) instructions in the literature accompanying the product.

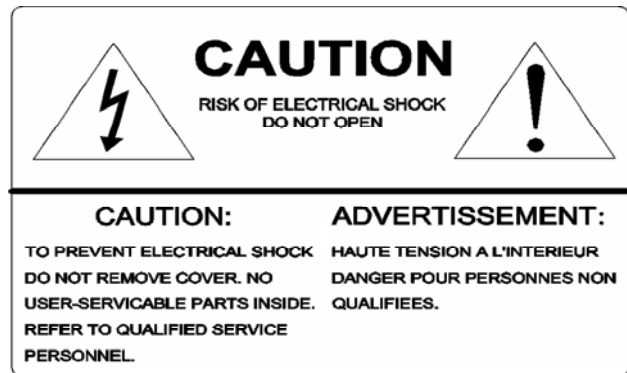

- Locate the system away from heat sources such as radiators, heat registers, stoves, or other heat producing products.
- **Do not** locate the dmc3-4 master or room stations in an outside wall.
- **Do not** expose the dmc3-4 to moisture. Doing so can create fire or shock hazards and impair the warranty.
- **Do not** place the dmc3-4 master or room stations in any wall cavity with any other electrical wiring in the cavity.
- **Do not** expose the dmc3RW, dmc4RW or dmc1RW outdoor patio speakers to significant water contact. The patio speakers are weatherproof but not waterproof. Continuous, direct water exposure will cause system problems.
- **Do not** attach devices unauthorized for use with this system. Authorized devices include:
  - Audio components connected via a line level input
  - dmc1CD 6-disc player
- Use only M&S Systems certified replacement parts and have them installed by an M&S Systems dealer or installer. Unauthorized substitutions can result in fire, electric shock, or other hazards.

- Upon completion of any service or product repair, have the M&S Systems dealer or installer conduct a safety check to ensure the system is in proper operating condition.
- Use only a damp cloth to clean the dmc3-4 master and room stations. Do not use liquid cleaners or aerosol cleaners.

## Cautions: Wiring

- A qualified electrician must run a 120V AC line to the dmc3-4 retrofit transformers.
- Individual wire runs should not exceed more than 350 FEET of wire from any single room station to the dmc3-4 master or 1000 total feet for the entire system.
- LABEL all wiring runs. Connecting the wires to the dmc3-4 master, room station or door stations incorrectly may result in system damage.
- Run a single cable from the master unit location to each room station and door station in a "home run" fashion. Do not loop cable from one room station to another.
- DO NOT STAPLE CABLES! Staples cause shorts.
- DO NOT SPLICE CABLES. Splices are unreliable and defeat the signal isolation properties of the cables.
- DO NOT RUN ELECTRICAL WIRES THROUGH THE DMC WALL HOUSINGS. If you encounter 120VAC wires running through a wall housing during a retrofit you must have a qualified electrician rerun those wires around the wall housing.
- KEEP CABLES AT LEAST 18 INCHES FROM FLORESCENT LIGHT FIXTURES, DIMMER CONTROLS, AND ALL OTHER WIRING. This includes AC wiring, security cable, cordless phone units, and other control wires. These can cause a "hum" or "buzzing" sound.

- KEEP cables away from objects such as heating and air conditioning ducts, metal construction plates, and anything else with sharp edges that can damage the cables.

### Cautions: Room Station Rough-In

Careful consideration should be used when determining the location of the room stations and master. Since this is a retrofit system you will not be able to control the location of the existing system. But please follow the guidelines below if you install any new locations:

- **DO NOT** install room stations in return air ducts.
- **DO NOT** install room stations in exterior walls. Insulation materials will change speaker range and efficiency. Temperature changes in the wall will reduce speaker life.
- **DO NOT** install room stations in saunas. They will not withstand the extreme heat and moisture.
- **DO NOT** install room stations underneath cabinets or over counter tops.
- **DO NOT** install room stations in stud cavities with other wiring or appliances.
- **DO NOT** install room stations within 18" of dimmers, fluorescent light fixtures, security wiring, cordless phone units, and other control wiring.
- **DO NOT** install room stations within 10 feet of other room stations or the dmc3-4 master unit. This will cause acoustic feedback.
- **DO NOT** install room stations in stud cavities with other room stations or the dmc3-4 master unit. This will cause acoustic feedback.
- **DO NOT** install room stations facing other room stations or the dmc3-4 master unit. This will cause acoustic feedback.
- **DO** make sure all mounting rings are level and oriented as shown in these instructions.

## Installation Overview

The dmc3-4 retrofit installation is completed using the following steps:

- Develop the job estimate
- Removal of the old intercom system
- Install the dmc1H or dmc1HC housing
- Replace the room stations (note do not remove the existing room station mounting rings)
- Install the optional dmc1CD player
- Install the dmc3-4 master and make all room station connections
- Test the system

The following tools are required for the dmc3-4 installation. The use of these or other tools is dependent on the existing intercom system installation:

- #2 Phillips screwdriver
- Wire stripper/cutter
- Tape measure
- Level
- Tin Snips
- Digital Multimeter (dmm)
- Small (or precision size) Philips/Flat head screw driver
- Power drill with 1" auger
- Small Crowbar
- Large Flat head screw driver
- Rubber mallet
- Extension cord

- Wood chisel
- Dry wall saw

You may not need to use all these tools on each install but having them handy will make the overall installation process easier.

## Develop the Job Estimate

It is critical that you determine the complexity of each retrofit installation prior to developing the job estimate. It is hard to predict all the unique situations you will encounter in the field. For this reason M&S Systems recommends you visit each retrofit site prior to developing a job estimate and ordering equipment. During this onsite visit it is recommended that you complete the items listed below:

- Determine the model number and manufacturer of the existing intercom system.
- Count the number of room, patio, and door stations.
- Determine if the door and patio stations are surface or flush mount.
- Remove the master from the wall to see if any non-standard installation situations might exist, including:
  - Electrical running through the wall housing
  - Telephone wires running through the wall housing
  - Stud spacing that varies from a standard 16" on center spacing
  - The type of wire used for room, door and patio station runs (M&S, NuTone or other such as telephone wire) - If you encounter non-standard wire contact our Technical Support team at 1-800-366-9422 for assistance.
  - A remote transformer
  - A remote door chime

The answers to the above information will help you scope, price and install the retrofit system.



## Removing the Old System

Prior to removing the existing intercom system make sure all power is turned off at the intercom location. Remove the screws from the intercom master and while removing the intercom, make sure to carefully label each wire with its corresponding room location. Disconnect all the room station and door station wires from the master. Then carefully remove the existing wall housing and transformers.

If the existing system was not working prior to replacement, check each wire run between the room stations and master for shorts and wiring integrity. If one of these room station to master wire runs has a short, re-run that wire prior to installing the dmc3-4. When replacing wire runs use M&S Systems MS4XSC shielded wire. This wire will work for both 3 and 4-wire installations. On 4-wire installations use the wire as is and on 3-wire runs do not use the white wire.

Note: if you encounter 120VAC running through the existing wall housing, have a qualified electrician reroute the 120VAC around the wall housing.

If you encounter a remote transformer, an additional electrical run may have to be made by a qualified electrician to power the dmc master and/or optional CD player. Also check to make sure that the area around the housing is clear of any additional 120VAC runs or other obstructions.

## Installing the Wall Housing

The dmc1H and dmc1HC housings are designed for 16" on center studs. You may encounter stud spacings that vary from this standard. Use the dmc1H housing when you are replacing an existing system with an intercom only system. The dmc1HC housing is used for

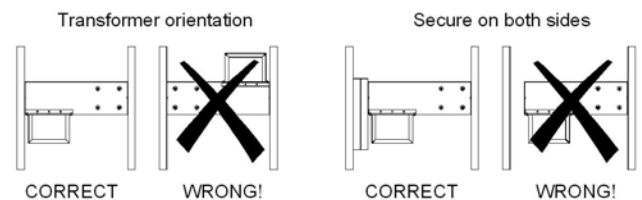

Figure 1 – Transformer location

combination systems only – or those that include the dmc3-4 master and the optional dmc1CD 6-disc CD player.

Locate wall housing dmc1H or dmc1HC (combo). The housing must be positioned so that the transformers are on the bottom of the wall housing as shown in figure 1. If you are replacing the existing master only system with a combination dmc3-4 system you will have to cut the rough-in opening larger to accommodate the larger wall housing. Prior to making the cutout check the stud cavity for obstructions or items in the wall that may prevent the transformers from fitting in the wall. The dmc1H and dmc1HC transformers drop in from the bottom of the housing. Refer to Figure 2 for wall housing placement.



**Figure 2 - dmc1H or dmc1HC wall housing placement**

The wall housing is designed to fit between 16" on center (OC) studs. In retrofit applications you may encounter stud spacing that varies from this standard.

Connect the existing, dedicated 120VAC/60Hz line with ground connection from the power panel to the wall housing as shown in Figure 3. The dmc3-4 requires a dedicated power source to assure no interference from other equipment caused by looped power circuits. The ground is necessary for proper radio reception.

Place transformer enclosure from the inside of the wall housing into the transformer enclosure opening at the bottom of the wall housing as shown in Figure 4. Do not run the 120VAC through the wall housing.

The wall housing is designed to fit between 16" on center (OC) studs. In

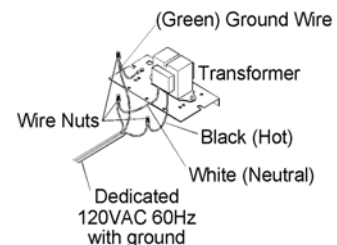

**Figure 3 - Transformer 120VAC/60Hz run**

For the dmc1HC combo wall housing have a qualified electrician loop a power wire from the TE5C transformer enclosure to the TE2C transformer enclosure following the same

procedure described above and shown in Figure 5.

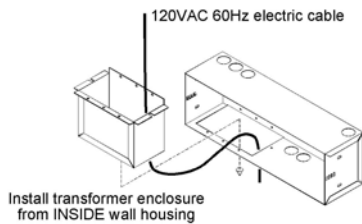

**Figure 4 – Transformer placement**

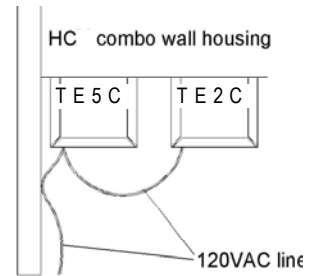
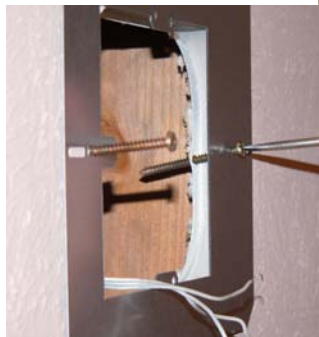

**Figure 5 - dmc3-4HC transformer connection**

## Replacing the Room Stations

The DMC room and door speakers use the existing wire and speaker rough-in mounting frames or boxes. To replace the speaker, first remove the old speaker. Leave the existing room or door station mounting rings in place.

After removing the room station verify the integrity of the wire run. Then install the mounting plate from the DMCFR (finish-out frame for room stations). Align the plate on the wall either vertically or horizontally so that the screw holes line up with those on the mounting ring or box. Use a level to make sure the plate is level. There are several screw hole locations on the mounting plate so it can attach to many rough-in designs. Mount the plate to the wall using the screws provided (Figure 6).



**Figure 6 - DMCFR installation**

Next connect the wires to the dmc retrofit room station as shown in Figure 7. Match the wire colors to the corresponding screw locations on the dmc3 or dmc4 room stations. Please make sure to use only dmc3 room stations in a 3-wire installation and dmc4 room stations in a 4-wire installation. All 6-wire installations use the DMC1 room stations. Please refer to appendix A for a diagram of which NuTone and M&S systems map to the 3, 4 or 6-wire (requires dmc1 master) configurations.



**Figure 7 - Room Station Wiring - 3-Wire**

Refer to the charts below for the dmc3-4 wiring diagram;

<b>NuTone Wire (IW3 or equivalent)</b>	<b>M&amp;S 3-Wire</b>	<b>dmc3-4 equivalent</b>
Silver outside or blue tracer	White	Black
Center conductor or gray tracer	Black	Red
Other outside copper wire or red tracer	Green	Green

<b>M&amp;S Wire</b>	<b>M&amp;S or NuTone 4-conductor gray jacket wire</b>	<b>dmc3-4 equivalent</b>
White	Silver outside gray wire	White
Black	Next copper outside gray wire	Black
Red	Next copper outside gray wire	Red
Green	Outside copper outside gray wire	Green

After connecting the room station to the existing wiring using the diagrams above. Place the room station through the DMCFR plastic mounting plate. Position the plate either vertically or horizontally depending on the room station replaced. Place the room station into the rough-in ring and align the frame with the room station as shown in Figure 8. Use the screws provided with the room station to screw the room station and frame into place. The holes in the room station align with the holes in the mounting plate. The room station keeps the plastic frame in place on the wall.



**Figure 8 - Placing Room Station in**

Note the plastic frames are paintable. Please prime the plastic first and then apply standard room paint. The white plastic may require two coats of paint to get full coverage. It is recommended that you paint the frame prior to mounting it to the wall.

**Important:** Please label all cables at both ends. Incorrectly connecting cables to the master, room stations or door stations could result in system damage.

## Patio Speakers

Do not remove the existing patio speaker rough-in. The DMC retrofit system is designed to fit into the existing enclosure. It is important to note that M&S patio speakers are weather resistant not water proof. M&S speakers should not be located in an area that is in direct line of water from sprinklers, rain or other devices such as power washers.

Please use the DMCFRW finish-out frame in outdoor and high sun areas. The DMCFRW plastic is designed to withstand sun and resist fading. If a patio requires a surface mount application use the

DMC1HRWS. This is a surface mount box and cover that will support the DMC1RW, DMC3RW or DMC4RW patio speakers.

To install a patio speaker follow the instructions presented above for interior room stations.

## Door Stations

Remove the old door station but do not remove the rough-in box or surface mount box. When replacing a NuTone door speaker you must use the DMCFD finish-out frame. The M&S door station sets in the DMCFD and the screws attach to the existing rough-in. Connect the door station with the corresponding color wires. Screw the door station or door station with DMCFD frame into the rough-in box as shown in Figure 9



**Figure 9 - DMCFD and Door Station Installation**

## External Music Source

The DMC retrofit system supports the use of external music sources. You can use an existing connection or run a new wire to support local source connection. To install a new local source follow the steps detailed in the following paragraphs.

Choose a location for the AWP that will be easily accessible to the sources that are to be connected to the system (close to the receiver, TV or DVD player for example). Note: the external source wire run to the dmc3-4 must not exceed 50 feet.

At this location, attach a single gang box to a wall stud at a center height of normal wall outlets. Use a low voltage plaster ring in existing construction installations.



Make sure the single gang box extends past the wall stud and into the room so it will be flush with the sheetrock when it is applied. Run the Red and Black shielded audio cables (included in the AWPRX) from the master unit location to the AWP location. Connect the cables.

## Installing the Chime Module

Install the optional chime module MC3 or MC8 in the wall housing by pressing the chime module over the 4 plastic standoffs attached to the wall housing as shown in Figure 10. Refer to the instructions shipped with the chime module.

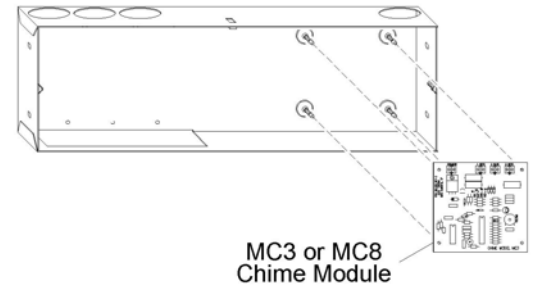

Figure 10 - Chime module installation

## Installing the dmc1CD player

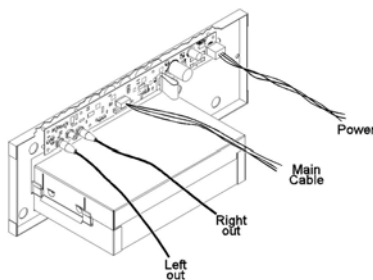

Figure 11 - dmc1CD connections

Connect the audio cables to the audio outlets of the dmc1CD player refer to Figure 11. After connecting the audio cables and main cable, connect the power cord from the TE2C transformer to the power connector on the dmc1CD.

Ensuring that nothing is between the CD player and the back of the wall housing (including cables), place the dmc1cd player into the lower opening of the finish out frames including the dmc1F or dmcFM frames. Use the screws provided to secure the unit in place.

# Installing the dmc3-4

The dmc3-4 ships configured for a 3-wire retrofit system. If you are replacing a 4-wire system you must change the jumper setup on the dmc3-4 master. The jumper change must be completed before any

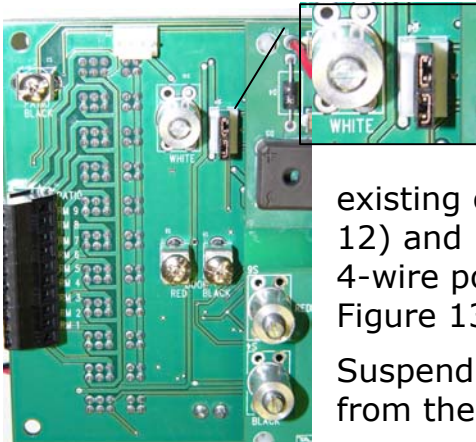

**Figure 12 - Default, 3-Wire Pin Position**

cables are connected. To change the jumpers just pull them off the existing connection (Figure 12) and place them in the 4-wire position show in Figure 13.

Suspend the master unit from the wall housing by

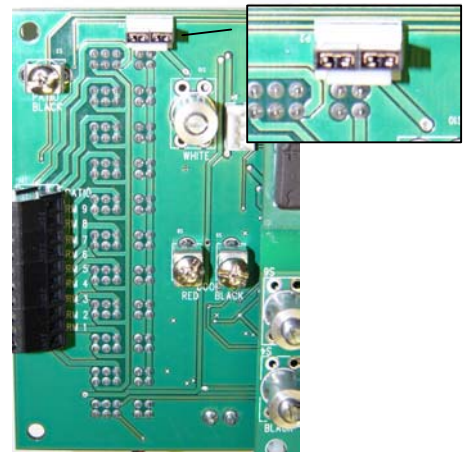
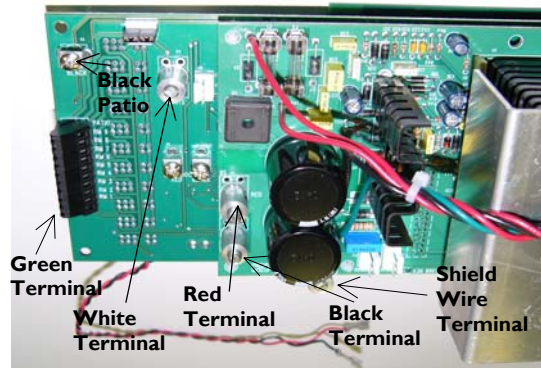

**Figure 13 - 4-Wire Pin Position**

looping the third hand wire (thick

green wire) over the hook at the top of the housing. Be careful not to damage the wall surface.

If the dmc3-4 system has more than 9 room stations, some room selector switches will control two room stations. Connect each Green wire (except patio Green) to a single green terminal on the master. Each numbered Green terminal corresponds to a remote station selector switch. Note: No more than 3 Green wires can be connected to any Green terminal and not to exceed 15 speakers for the 4-wire or 13 speakers for the 3-wire system. This limitation does include remote controls and volume controls but not door stations. The station location can be



**Figure 14 - dmc3-4 master wire connections**



marked on the inside of the door access panel on the left side of the dmc3-4 master.

Connect the green wire(s) from the patio station(s) to the Patio green terminal. Connect the patio Black wire(s) to the patio Black terminal. Note: Only two patio stations can be connected to the patio terminals. Connect the Red wire with the other Red wires to the Red terminal. Connect the White wire with the other White wires to the White terminal. Refer to Figure 14 for wire placement.

Connect the red and black wires of the door station cables (MS4DCX/MS4DCXSC) to the red and black door speaker terminals on the dmc3-4 master as shown in Figure 15. When using MS4DCXSC shielded wire, insulate the bare wires using some of the jacket material to prevent shorting to the circuit board. Connect this wire to terminal labeled shield. Connect all orange wires from the door stations to the common terminal on the MC3 or MC8. Connect each yellow wire to a note selection terminal. (Do not connect more than one yellow wire per note terminal.)



**Figure 15 - Door Station Connections**

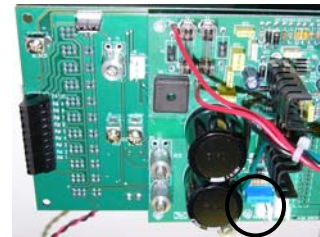

**Figure 16 - Chime Plug Connection**

Plug in the modular chime plug to the 4 pin connector labeled as CHIME on the dmc3-4 master unit as shown in Figure 16.

Connect the optional dmc1CD player RCA cables and control wire.

## Connecting the Antenna

Separate the intercom cables from the antenna leads, if grouped together the intercom cables can shield the antenna leads resulting in poor radio reception. Keep the antenna leads away from metal ductwork and aluminum backed insulation. These can also shield the antenna leads.

The number and style of antenna leads will vary based on the intercom system being replaced. The dmc3-4 system is designed to use the existing antenna.

Follow the steps below to attach a NuTone 300 Ohm twin lead antenna to the dmc3-4.

1. If the antenna has a plug on the end, cut the plug off
2. Strip the 2 wire ends
3. Connect the wire ends to terminal S1 and S2 on the antenna board
4. Connect a bare jumper wire (a 22 gauge speaker wire works well) between the S3 and S4 terminals.

Follow the steps below to attach a separate AM/FM antenna system with 300 Ohm FM twin lead and orange AM antenna wire:

1. Connect the FM twin leads to terminal S1 and S2 on the board
2. Connect the AM antenna (orange wire) to terminal S4
3. Terminal S3 is not used in this configuration

Follow the steps below to connect a single orange wire antenna system:

1. Connect the orange wire to either S1 or S2. Note do not connect the wire to both S1 and S2 doing this will short out the FM antenna signal.
2. Connect a bare jumper wire (a 22 gauge speaker wire works well) between the S3 and S4 terminals.

## Wireless Remote Control Connection

To install the optional wireless remote control receiver module MCRC, attach the MCRC module using the Velcro strips provided to the wall housing. Place the white antenna lead through the hole provided in the wall housing into the wall cavity. Failure to do so may result in poor range of the wireless remote control system. Connect the wire harness from the MCRC to the connector labeled REMOTE on the master.

After the master is installed you must program the transmitter. Complete this step after completing the system test. To program the transmitter simultaneously press and release the AUTO and SOURCE buttons. The display will show RF and SET on it. Then press and hold any button on the remote until the RF and SET disappear from the display. To cancel this function, simultaneously press AUTO and SOURCE.

## MC960 Power Amp Installation

Run the MS7XSC cable from the dmc1H or dmc1HC wall housing to the remote power amplifier.

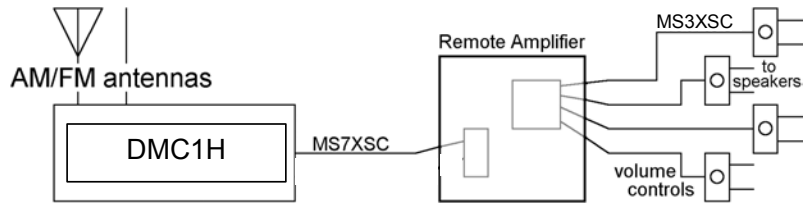

Figure 17 - Power amp wiring

Run the MS3XSC cable from the remote amplifier to each volume control (use the SVC96 for stereo or the MVC1 for mono).

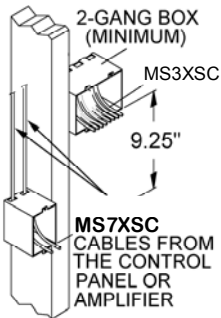

Figure 18 - Power amp installation

From each volume control, run the MS2SXSC to each respective speaker as shown in Figure 17.

The remote power amplifier should be located in a closet or utility closet and should be located within 6 feet of a standard NEMA 5-15R 120VAC receptacle. Install a 1-gang

and a 2-gang box at the location for the remote amplifier on a

stud. Allocate the 1-gang and 2-gang boxes relative to one another as shown in Figure 18. Run all MS3XSC cables from the volume controls to the remote amplifier's 2-gang box.

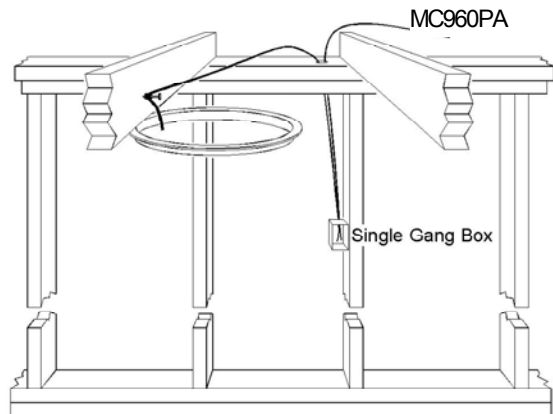

Figure 19 - Speaker installation

Run the MS7XSC cable from the dmc3-4 to the remote amplifier's 1-gang box. The remote amplifier is designed to mount over the 1-gang and 2-gang boxes on a single stud. Note: The speaker cables CANNOT be located in the same gang box used for 120VAC wiring.

Each pair of stereo or mono music speakers is controlled by a single volume control. The volume controls install in a standard single gang box. Run a MS3XSC cable from each volume control location to the remote

amplifier. From each volume control location, run a MS2SXSC cable to each satellite speaker (left & right) or mono as shown in Figure 19.

Install the appropriate mounting ring for each respective speaker. Follow the instructions included with the speaker for specific dimensions on the mounting ring. Secure the MS2SXSC cable from the speaker's respective volume control to avoid drywall damage.

## Door Release Options

The door release option is a dry contact closure provided by the dmc3-4 master. This dry contact is rated 24V at 2 Amps. The sample applications below represent some uses of this option. However, only one application can be used in any dmc3-4 system at a time.

### Door or Gate Release Mechanism

Run a single line of PBVM127X1 from the dmc1H or dmc1HC housing to the door release mechanism. Connect the red and white wires to the two wire terminals of the door release mechanism.

Run another single line of PBVM127X1 from the dmc1H or dmc1HC housing location to a gang box next to a 120VAC receptacle where the remote power transformer (part #240054) will be plugged in. Label and secure cables at the housing.

The door release switch contacts are very versatile and can be used with many AC/DC door or switch contacts. Be sure to use the wire and power supply or transformer specified by the door or gate release product being used.

### Panic Interface with Security System

Run a line of PBVM127X1 from the dmc1H or dmc1HC housing location to the security control panel. Setup the security panel to receive a normally open dry contact for panic operation. (Refer to programming procedures accompanying the security panel). Label and secure cables at the dmc1H or dmc1HC housing. Have a certified security installer hook the dmc3-4 up to the alarm system.

## Test the System

After all connections have been made, insert the dmc3-4 power plug into TE5C transformer and secure the master to the wall housing using the 2 screws provided. If using the dmc1F, dmc1FC or dmc1FM frame with a dmc1CD player, install the master unit over the frame. Do not over tighten the screws as the plastic may distort or crack. Install the speaker panel on the master as shown in Figure 20.

Please be careful to only apply pressure on the speaker panel at the corners and not in the middle. Check all functions by following the guidelines in the Owners Manual shipped with the master unit. If any difficulties are encountered, recheck all connections. If after reviewing these instructions you are unable to resolve any problems, contact technical support at 1-800-366-9422.

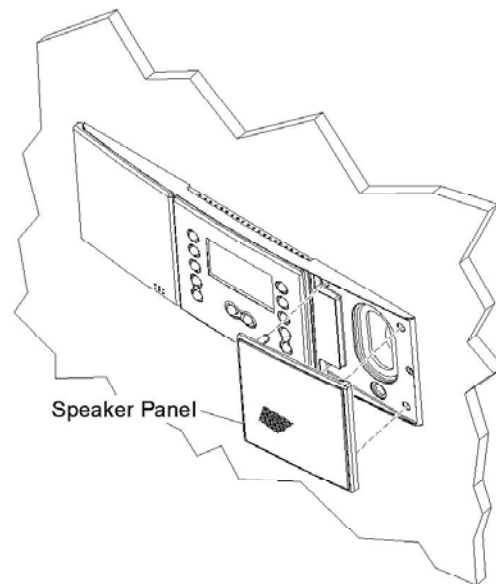

**Figure 20 - Speaker Panel Placement**

# Appendix A – NuTone Systems

M&S Part Number	NuTone IM-3303	NuTone IM-4406	NuTone IM-3204
DMC1		X	
DMC3-4	X		X
DMC1R, DMC1RS		X	
DMC1RW		X	
DMC3R, DMC3RS	X		
DMC3RW	X		
DMC4R, DMC4RS			X
DMC4RW			X
DMC1CD	X	X	X
DMC1F	*	*	*
DMCFM	X	X	X
DMCFC			
DMCFR	X	X	X
DMCFD	X	X	X
DMC1H	X	X	X
DMC1HC	*	*	*
DMC1HR			
DMC1HRW			
DMC1HRWS	X	X	X
MC3/MC8	X	X	X
DS3B	X	X	X
BD3BN	X	X	X
D3BN	X	X	X
MCRC	X	X	X
MCTX	X	X	X
DMCRA		X	

- \* Refer to frames below:
- DMCFM – Replacing a master only system with a dmc3-4 master
  - DMCFC – Replacing a combination system with a dmc3-4 and a dmc1CD
  - DMC1F – Replacing a master only system with a dmc3-4 and a dmc1CD (requires hole in wall to be made larger)
  - DMCFR – Used on all indoor room station replacements
  - DMCFRW – Used on all outdoor or high sun area flush mount room station replacements
  - DMC1HRWS – Used on all outdoor surface mount room station replacements
  - DMCFD – Used on NuTone door station replacements, not required for M&S replacements

The following NuTone systems map to either the IM-3303 or IM-4406 systems:

NuTone Systems	IM-4406	IM-3303
SM428	X	
2561/2562	X	
2401/2402	X	
2542	X	
2540/2541	X	
IM-406	X	
IM-4006	X	
IMA-303		X
IMA-203D		X
IMA-2003		X
IMA-3003		X
IMA-3303		X
2067/2068		X
2011/2012		X
2015/2016		X
2053/2054		X
2055/2056		X
2071		X
2031/2032		X
2090/2091		X
M-3103		X
IM-203		X
IM-313		X

# Appendix B – M&S Systems

M&S Part Number	M&S 602	M&S MC602 with MCP/MDC6	M&S MC702	M&S MC702 with MCP/MCD6	M&S 302	M&S MC302 with MCP/MDC6	M&S 440 Series	M&S 500 Series	M&S 40 Series
DMC1			X	X			X	X	X
DMC3-4	X	X			X	X			
DMC1R, DMC1RS			X	X			X	X	X
DMC1RW			X	X			X	X	X
DMC3R, DMC3RS									
DMC3RW									
DMC4R, DMC4RS	X	X			X	X			
DMC4RW	X	X			X	X			
DMC1CD	X	X	X	X	X	X	X	X	X
DMC1F	*		*		*		*	*	*
DMCFM	X		X		X		X	X	X
DMCFC		X		X		X			
DMCFR	X	X	X	X	X	X	X	X	X
DMCFD									
DMC1H	X		X		X		X	X	X
DMC1HC	*	X	*	X	*	X	*	*	*
DMC1HR									
DMC1HRW									
DMC1HRWS	X	X	X	X	X	X	X	X	X
MC3/MC8	X	X	X	X	X	X	X	X	X
DS3B	X	X	X	X	X	X	X	X	X
BD3BN	X	X	X	X	X	X	X	X	X
D3BN	X	X	X	X	X	X	X	X	X
MCRC	X	X	X	X	X	X	X	X	X
MCTX	X	X	X	X	X	X	X	X	X
DMCRA			X	X			X	X	X

M&S Part Number	M&S 44 Series	M&S Model 5	M&S Model 6	M&S 220/330	M&S 250	M&S 300/350	M&S 350A	M&S 20 Series	M&S 30 Series	M&S Model 150
DMC1	X									
DMC3-4		X	X	X	X	X	X	X	X	X
DMC1R, DMC1RS	X									
DMC1RW	X									
DMC3R, DMC3RS		X								
DMC3RW		X								
DMC4R, DMC4RS			X	X	X	X	X	X	X	X
DMC4RW			X	X	X	X	X	X	X	X
DMC1CD	X	X	X	X	X	X	X	X	X	X
DMC1F	*	*	*	*	*	*	*	*	*	*
DMCFM	X	X	X	X	X	X	X	X	X	X
DMCFC										
DMCFR	X	X	X	X	X	X	X	X	X	X
DMCFD										
DMC1H	X	X	X	X	X	X	X	X	X	X
DMC1HC	*	*	*	*	*	*	*	*	*	*
DMC1HR										
DMC1HRW										
DMC1HRWS	X	X	X	X	X	X	X	X	X	X
MC3/MC8	X	X	X	X	X	X	X	X	X	X
DS3B	X	X	X	X	X	X	X	X	X	X
BD3BN	X	X	X	X	X	X	X	X	X	X
D3BN	X	X	X	X	X	X	X	X	X	X
MCRC	X	X	X	X	X	X	X	X	X	X
MCTX	X	X	X	X	X	X	X	X	X	X

## M&S Systems 2-Year Warranty

M&S Systems warrants its products to be free of defects for 2 years. The warranty period begins on either (a) the date of purchase or installation date of this product or (b) the date of closing on a new residence in which this product was originally installed. The warranty extends to the original user of the product and to each subsequent owner of the product during the term of the warranty. M&S will repair or replace, at its option, parts and materials at no charge. Parts supplied under this warranty may be new or rebuilt at the option of M&S Systems.

If during the warranty period the product appears to have a defect, please call our toll free service number (800-366-9422) prior to dismantling. Dismantling the product prior to calling our service number may void the warranty. Before returning any product to M&S Systems, obtain a Return Authorization Number (RAN) from our service department. M&S Systems will return the repaired product freight prepaid within the continental United States. ANY PRODUCT RETURNED TO M&S SYSTEMS WITHOUT A RAN NUMBER WILL BE REFUSED.

This limited warranty is in lieu of any other warranties, express or implied, including any implied warranty of merchantability or fitness for a particular purpose or otherwise, and of any other obligations or liability on the seller's part. This limited warranty does not cover damage caused by improper installation, acts of God, criminal acts, the violation of applicable building or electrical codes or the use of non-M&S wire, cable (excluding CAT5 and RG-6) or wall housings.

Under no circumstances shall M&S Systems be liable for consequential, incidental or special damages arising in connection with use, or inability to use this product. In no event shall M&S Systems liability hereunder exceed the cost of the product covered hereby. No person is authorized to assume for us or obligate us for any other liability in connection with the sale of this product. Some states do not allow the exclusion or limitation of consequential, incidental or special damages, so the above limitation or exclusion may not apply to you. This limited warranty gives you specific legal rights, and you may also have other rights, which vary from state to state.

116002-2